

Article number: 03441180

Description: Fluro Rod end GE 180EC-2RS

Measures

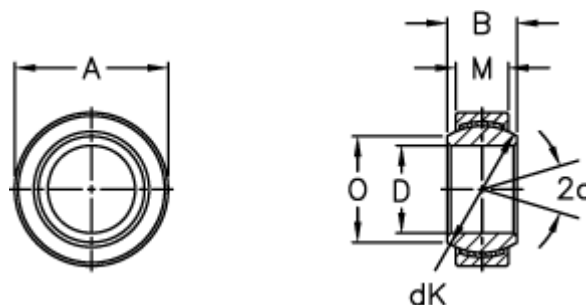

A = 260 0 -0,035

B = 105

D = 180 0 -0,025

dK = 225

Dynamic load C (kN) = 2880

M = 80

O = 198.9

Static load C0 (kN) = 5760

Tilt angle = 6

Weight = 18500